

# AR-PA

## TURISMO cultural

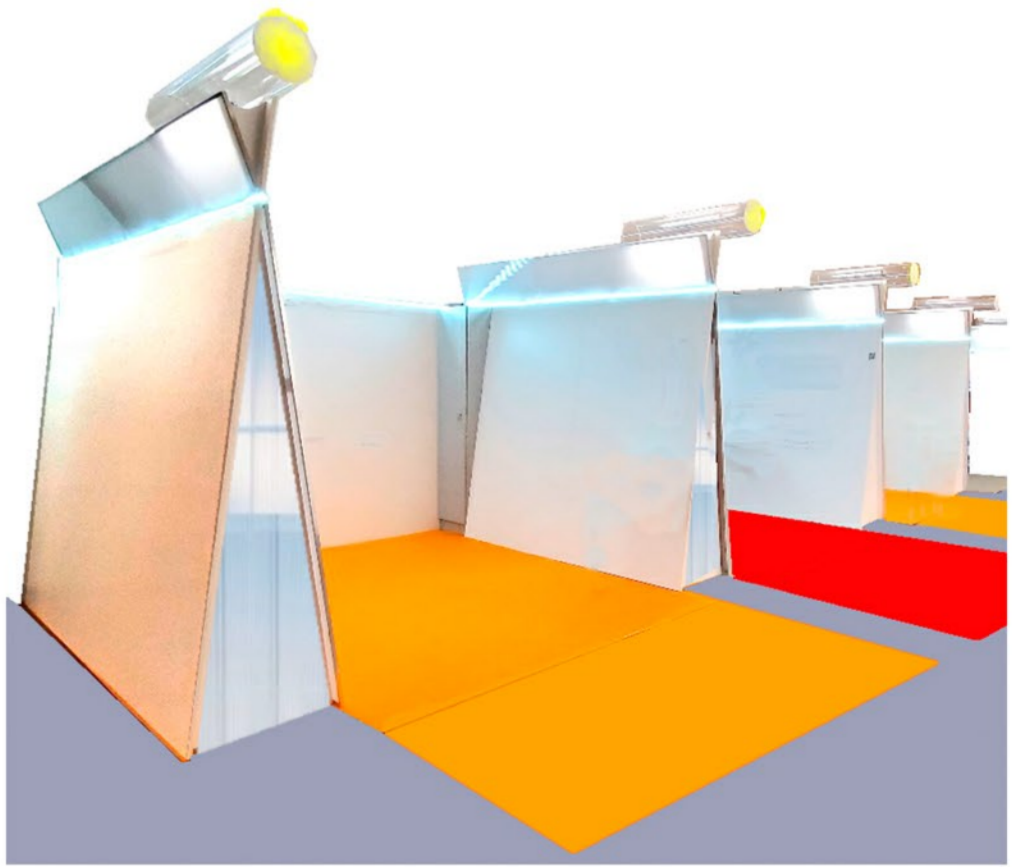
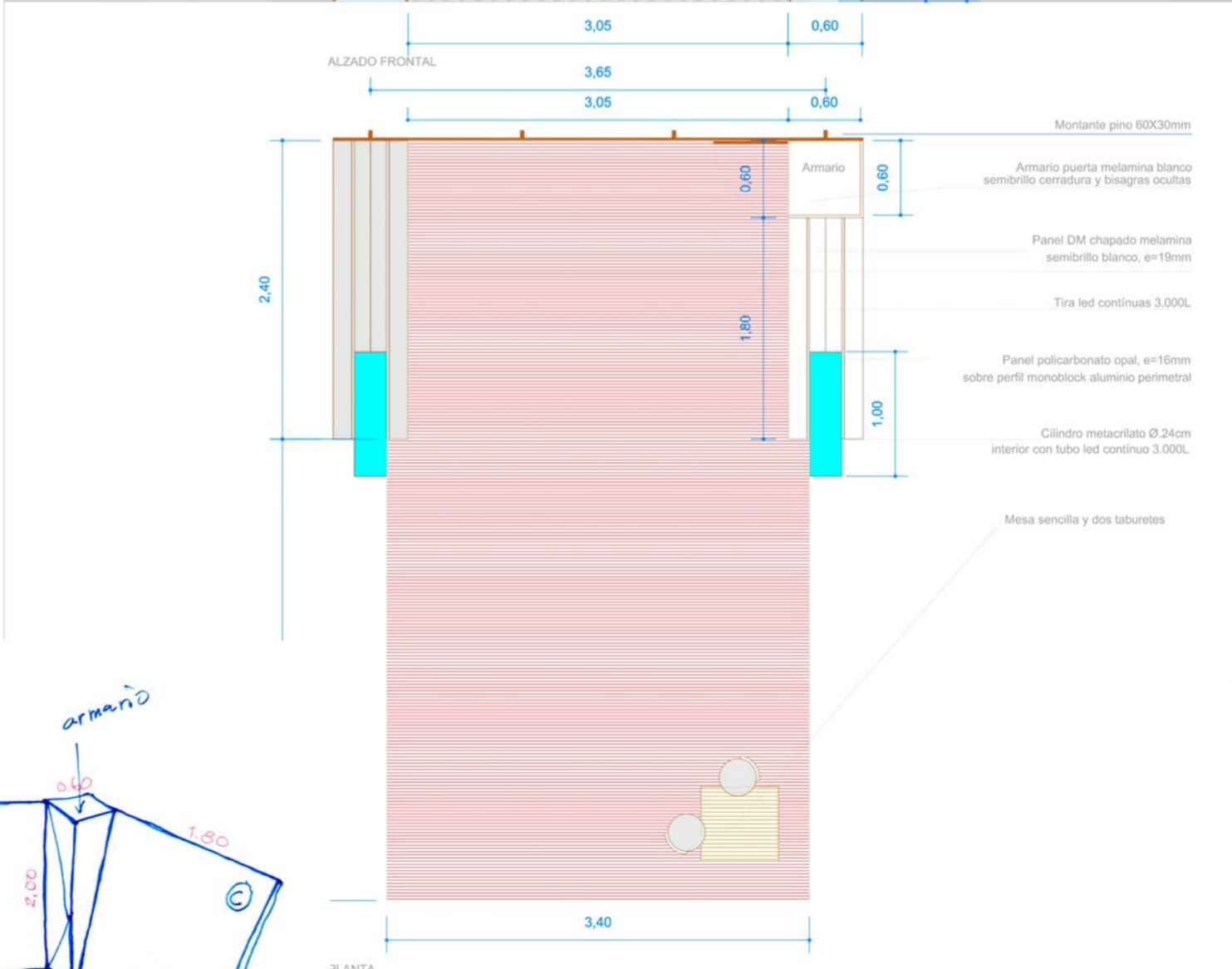
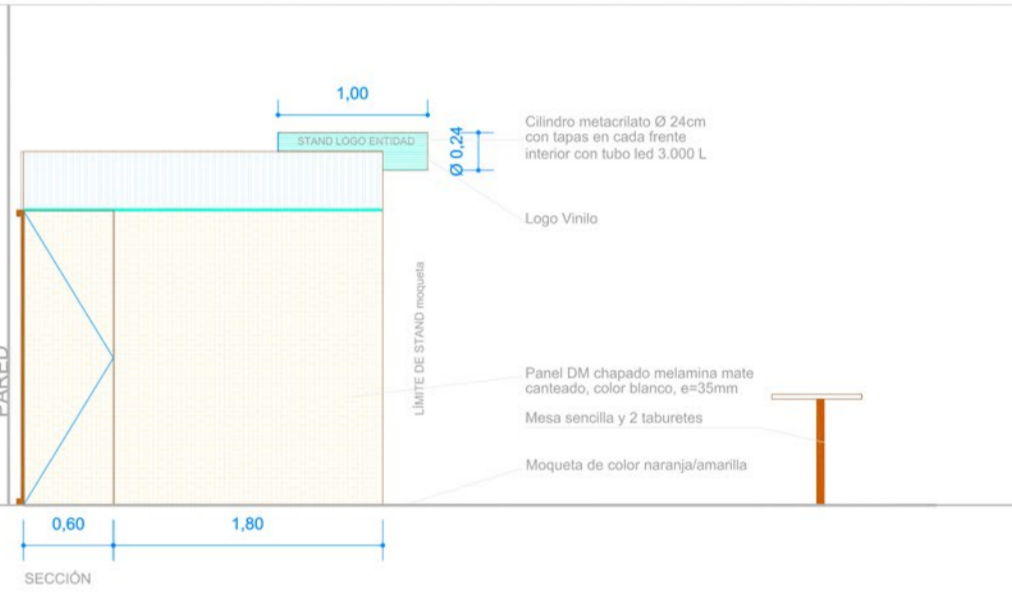
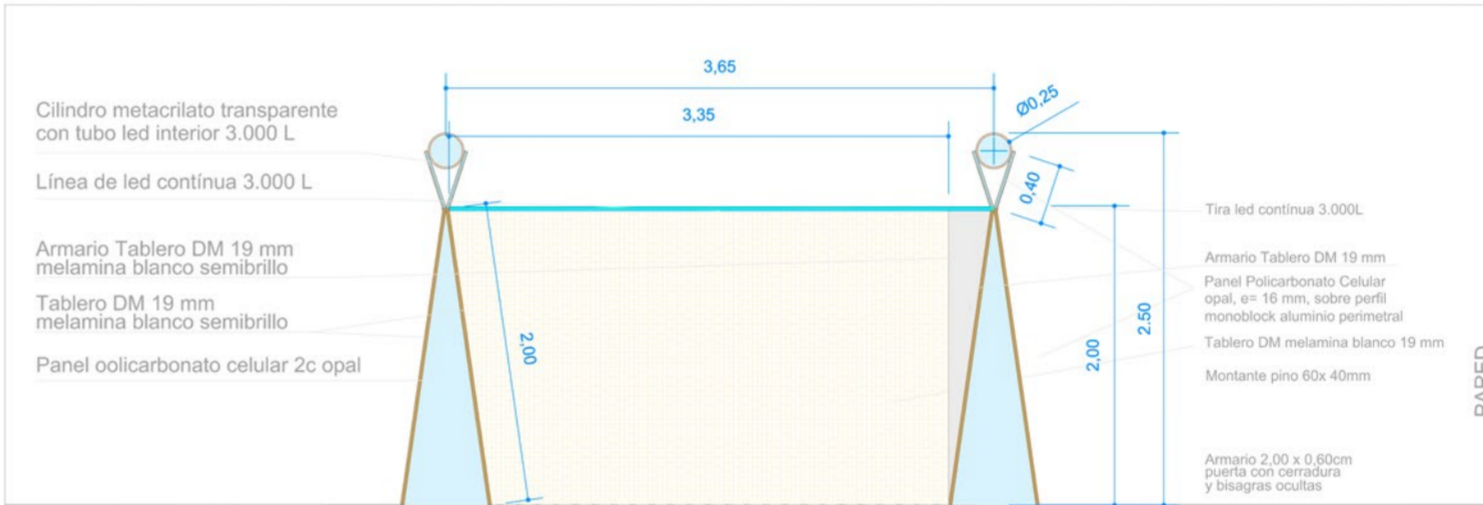
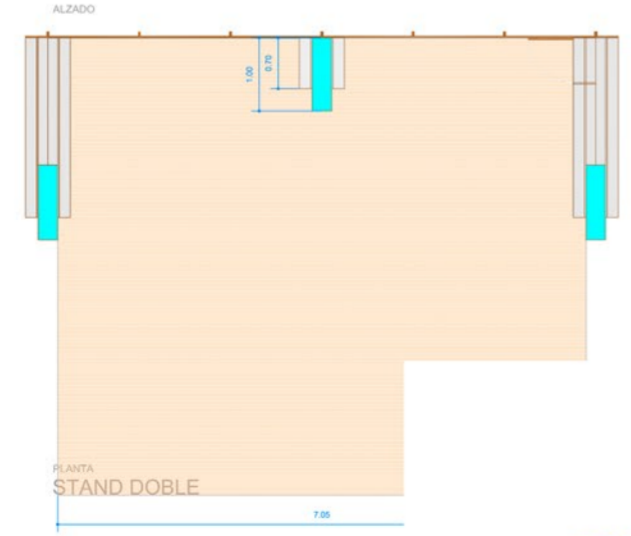
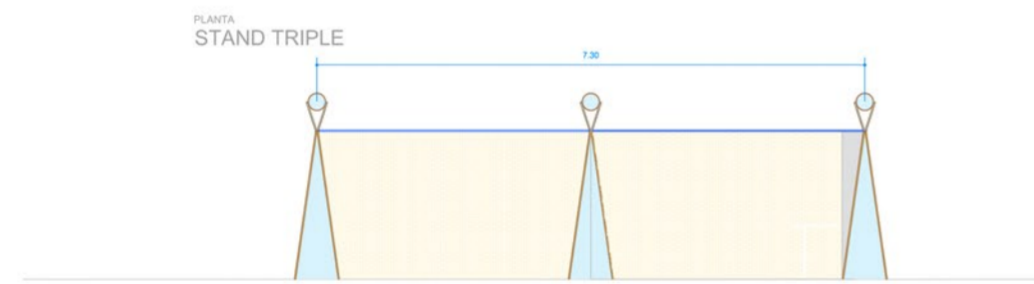
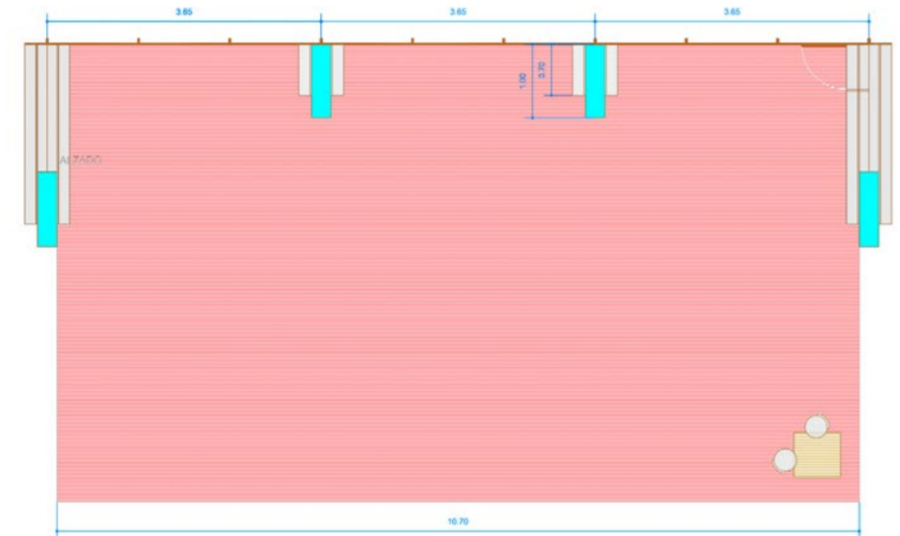
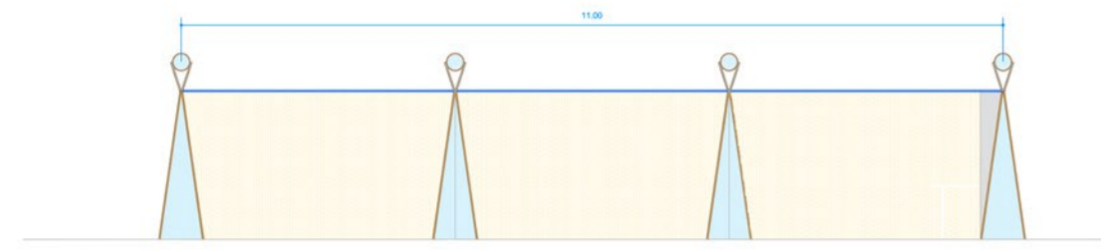

SUPERFICIE ÚTIL 20 m2

Las dimensiones son orientativas, dependen del ajuste del montaje "in situ"

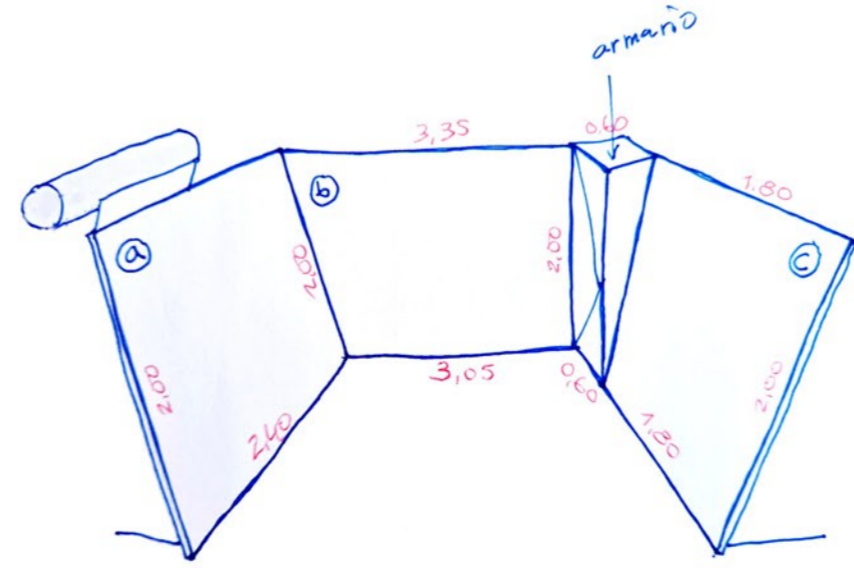

**Junta de Castilla y León**  
Consejería de Cultura Turismo y Deporte

Dirección General de Patrimonio Cultural